

MDS SA-CD PLAYER DP-570



Accuphase Laboratory, Inc.

In 2008, Accuphase released DP-600 as a standard model to playback both SA-CD and CD.

The new DP-570 is the 4th generation of this line with improved SA-CD/CD drive and ultra low THD and noise performance, compared to the former DP-560 which was released in 2016.

In order to pursue the accurate data reading, the vibration analysis of the laser pickup is performed, and the careful design including the housing thoroughly eliminates the adverse effect on the disc reading.

Equipped with a USB input that supports various digital sources.

Combining the latest technology and reliability, the DP-570 will be a way to extract all information contained in your SA-CD / CD collections and will take you to the next step in the ideal disc playback experience.

Front display

- High Visibility: Sampling Frequency & Number of Effective Bits

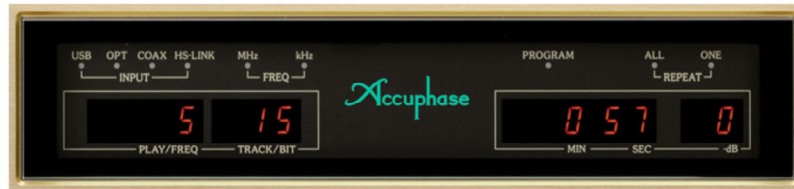

Accuphase Laboratory, Inc.

DP-570 can show the sampling frequency and the number of effective bits of all input signals on the front display.

Internal view

- Fully separated circuit & solid construction



Internal View

Accuphase Laboratory, Inc.

DP-570 is applied the systematical layout. Each circuit block is logically placed to make the signal path short as possible.

The digital circuit is on the right side and the analog circuit is on the left side at the rear panel.

Logic control board is on the right side of SA-CD drive mechanism, and on the left side, reinforced power supply is installed with the power transformer.

SA-CD / CD Drive

- Larger bridge cover to reduce motion noise
- High performance vibration absorber

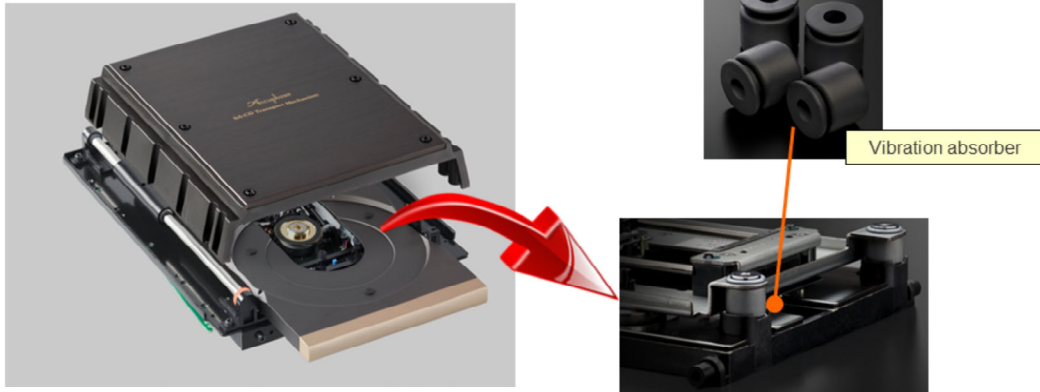

SA-CD / CD Drive Mechanism

Accuphase Laboratory, Inc.

Large bridge cover is very effective to reduce the motion noise coming from the motor drive and the disc rotation. This cover is three storied parts, molded base, iron insulator, and aluminum cover. There are uncountable air gaps between each materials to absorb the vibrations.

Furthermore, laser pickup module is mounted on the vibration absorbers. Those are made of the butyl rubber which is carefully selected from many kinds of rubber materials specially for this mechanism.

Vibration Analysis

- Decrease resonance point

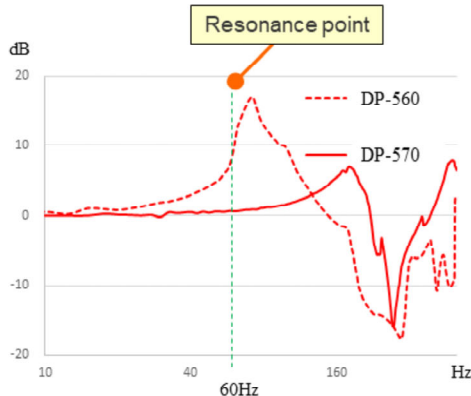

Laser Pickup Vibration gain
(Vertical)

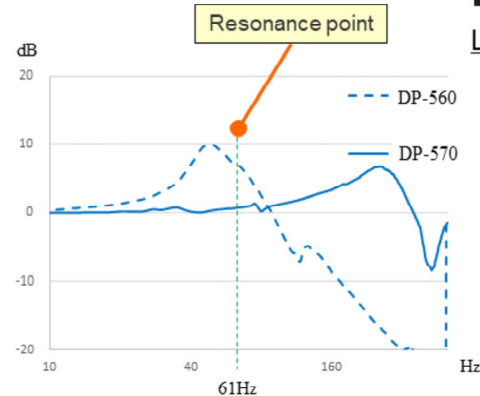

Laser Pickup Vibration gain
(Horizontal)



Laser Pickup

Accuphase Laboratory, Inc.

In order to accurately read the signal engraved on the disc, it is important that no extra vibration is transmitted to the pickup module.

In addition to the external vibration, the internal vibration coming from the high-speed disc rotation or the power transformer should be shielded.

The development team of DP-570 performed the vibration analysis to decrease resonance points so that even minute vibrations generated from inside the chassis does not affect the reading accuracy.

Electrical Performance

- Ultra Low Noise

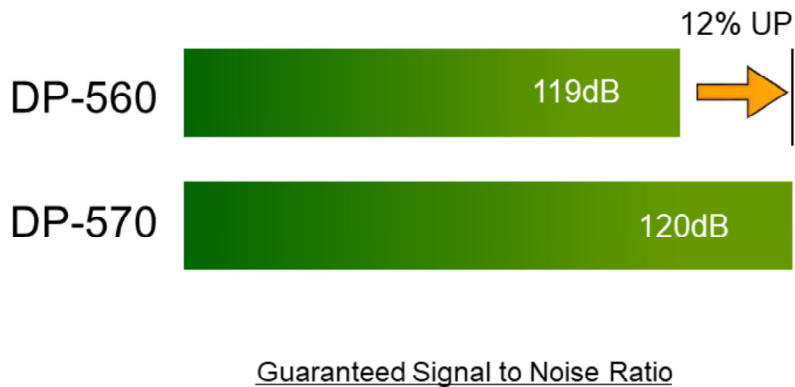

Accuphase Laboratory, Inc.

Ultra Low Noise is one of the main technical features of DP-570.

The former model, DP-560 still has the excellent noise performance, however, DP-570 achieves 12% lower output noise voltage than DP-560.

DP-570 guarantees 120dB Signal to Noise ratio which means 2.5 μ V of output noise voltage.

Electrical Performance

- Ultra low THD+Noise

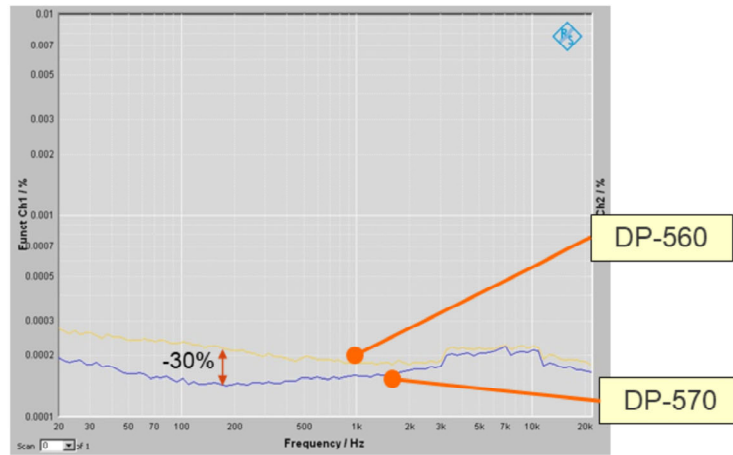

THD + Noise to Frequency

Accuphase Laboratory, Inc.

DP-570 proudly shows the great THD+Noise characteristics which are quite important for music playback, and this clearly proves that DP-570 obtains the 30% lower THD+Noise characteristics than DP-560.

D/A converter

- 4 parallel D/A converters per channel
 - ES9028PRO 32bit Hyper StreamII DAC
 - MDS+ Architecture for all digital signals
- Direct Balanced Filter
 - Balanced connected independence post filters

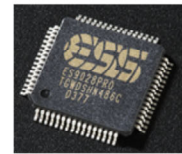

ES9028PRO

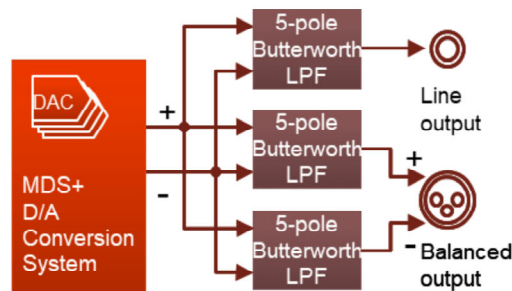

Accuphase Laboratory, Inc.

For D/A converter section, Accuphase updates the DAC chip to ESS Technology's 32bit Hyper StreamII DAC ES9028PRO for DP-570. This is the same DAC as in DP-750.

ES9028PRO has 8 DACs inside, and DP-570 uses 4 DACs connected in parallel per channel with Accuphase's unique technology, MDS+ conversion system.

Fully-balanced structure is employed after D/A converter section in DP-570.

In addition, the independent low pass filter is installed for each audio output, thanks to this, the sound signals from all the outputs become high quality.

Digital Inputs

- HS-LINK
 - Version1: 192kHz/24bit, 2.8224MHz/1bit
 - Version2: 384kHz/32bit, 5.6448MHz/1bit
- Coaxial: 192kHz/24bit
- Optical: 96kHz/24bit
- USB2.0: 384kHz/32bit, 11.2896MHz/1bit



Accuphase Laboratory, Inc.

DP-570 has 4 digital inputs, Coaxial, Optical, HS-LINK and USB.

USB Input accepts 384kHz/32bit-PCM or 11.2896MHz-DSD. DSD data can be received both DoP (DSD over PCM) and ASIO2.1.

HS-LINK has been evolved into Version2. Original HS-LINK(Ver.1) transmits and receives only 192kHz/24bit-PCM or 2.8224MHz-DSD, but Ver.2 comes to be able to transmit and receive up to 384kHz/32bit-PCM, 5.6448MHz-DSD.

DP-570 automatically recognizes either Ver.1 or Ver.2 transmission.

HS-LINK Version2 Available

- HS-LINK is upgraded to Ver.2
 - Transmits master clock separately
 - Supports up to 384kHz/32bit-PCM,5.6448MHz-DSD
 - Use the same HS-LINK cable as Ver.1
- HS-LINK Ver.1 output is still available.
 - Backward compatibility.



Accuphase Laboratory, Inc.

HS-LINK Version 2 extends the HS-LINK standard.

For backward compatibility, DP-570 is still available HS-LINK Ver.1 output.

HS-Link Version2 Advantages

- Transmitting the master clock separately
 - No Jitters occurred from Clock Recovery circuit

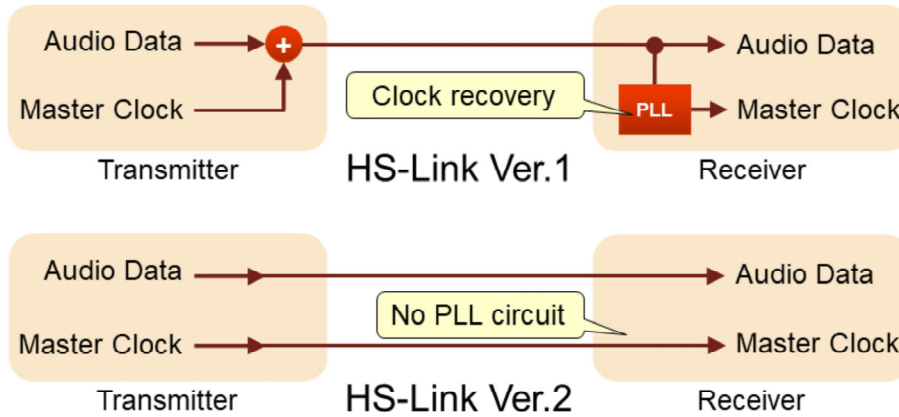

Accuphase Laboratory, Inc.

The biggest feature of HS-LINK Ver.2 is sending the music signal and the master clock separately to D/A converter in a receiver.

HS-LINK Ver.1 sends the music signal merging the master clock together, the PLL circuit to recover the master clock needs to be located at the receiver side.

Since master clock has been transmitting as it is, in HS-LINK Ver.2, not only master clock recovery is unnecessary at receiver side but it comes to be free from the jitter at the PLL circuit.

“DATA Disc” Available

- New SA-CD drive can play DATA Disc which is made with your PC

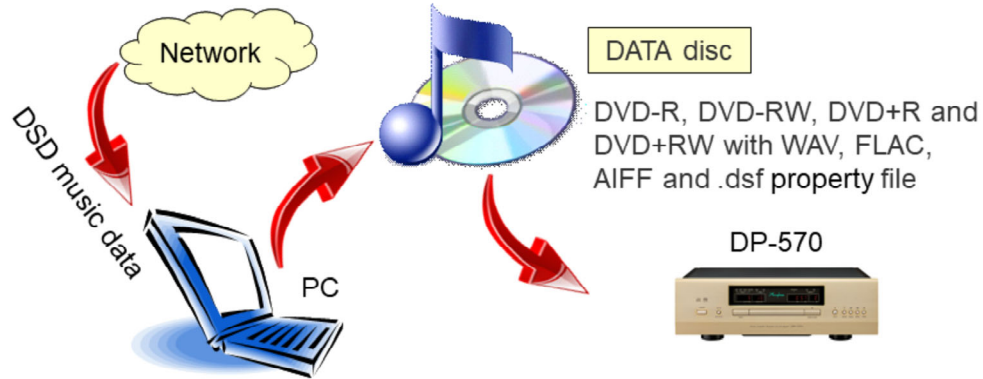

Accuphase Laboratory, Inc.

DATA Disc playback is available.
You can record music files on blank DVD by using your PC.

DP-570 can play 192kHz 24 bit data of WAV, FLAC, AIFF format, and 5.6MHz 1bit DSD data also.

You can enjoy many kinds of digital data with DP-570.

Furthermore

- Hair-line” finished aluminum top plate
- Programmable play mode available

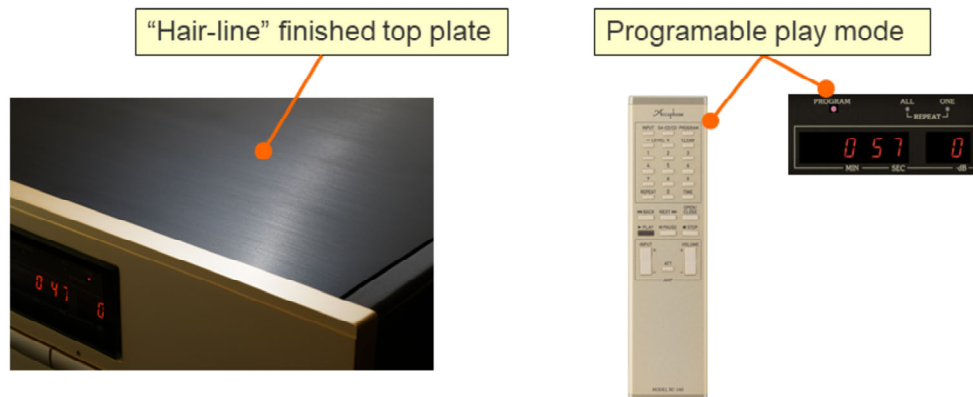

Accuphase Laboratory, Inc.

DP-570 applied the aluminum “hair-line” finished top plate. It brings an elegant atmosphere with gray metal finished side panels.

DP-570 also provides a programmable playlist feature, It allows you to enjoy listening in the order you prefer.